

SubConn® Low Profile

9 contacts

Connector specifications

Voltage rating	600 V DC/AC rms
Current rating	10 A per contact (max 40 A per connector)
Insulation resistance	> 200 Mohm
Contact resistance	< 0.01 ohm
Wet matings	> 500 (open face rated)
Temperature rating (water)	- 4 to 60°C, 25 to 140°F
Temperature rating (air)	- 40 to 60°C, - 40 to 140°F
Storage temperature rating	- 40 to 60°C, - 40 to 140°F
Qualified pressure tested	800 bar, 11,600 psi
Depth rating PEEK	300 bar, 4,350 psi

Material specifications

Connector body	Chloroprene rubber
Bulkhead body	Brass, stainless steel, titanium, anodised aluminium or PEEK
Contacts	Gold plated brass UNS - C36000
O-rings	Nitrile
Locking strap	Chloroprene rubber
Inline cable (2 ft, 60 cm)	16 AWG, 1.31 mm ² chloroprene rubber
Bulkhead leads (1 ft, 30 cm)	18 AWG, 0.82 mm ² coloured PTFE
OM leads (3", 7 cm)	18 AWG, 0.82 mm ² coloured PTFE

Face view (male)



Inline cable colour code

1 Black	4 Green	7 White/black
2 White	5 Orange	8 Red/black
3 Red	6 Blue	9 Green/black

Nominal cable outside diameter (OD)

9 conductor cable 0.590", 15.0 mm

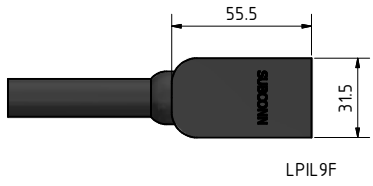

LPIL9F

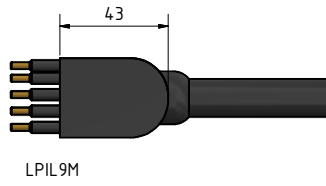

LPIL9M

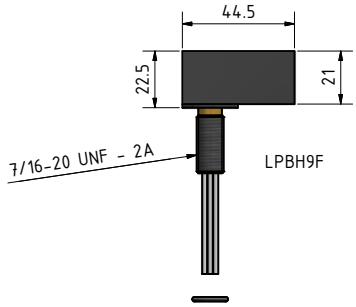
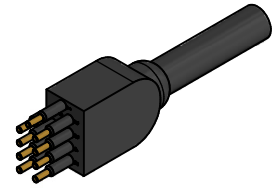

LPBH9F

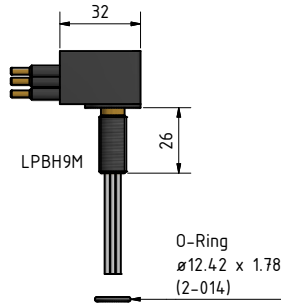

LPBH9M

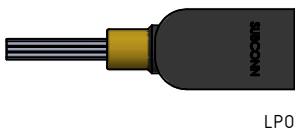
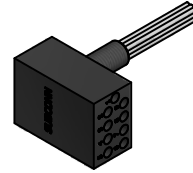

LPOM9F

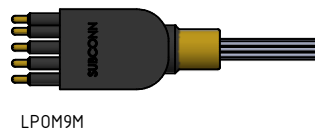

LPOM9M

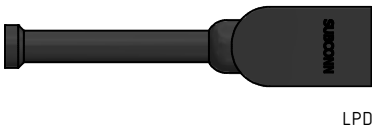
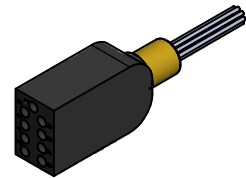

LPDC9F

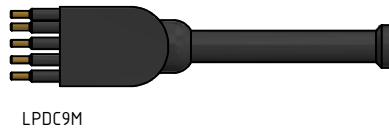

LPDC9M

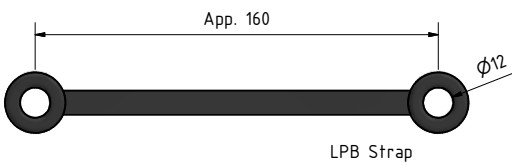
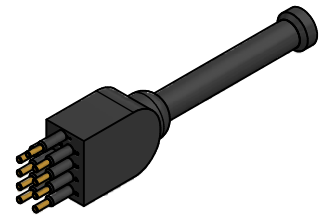

LPB Strap

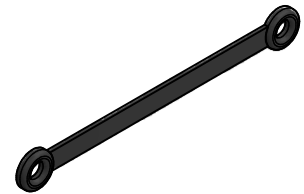

Drawing information

Dimensions in mm (1 mm = 0.03937 inch)
Threads in inches (1 inch = 25.4 mm)