

Cable Status Indicator MKII



Table of contents

1	Technical Description	3
2	Specifications	3
2.1	Electrical	3
2.1.1	Display/electronics unit	3
2.1.2	Sensor unit	3
2.2	Mechanical	3
2.2.1	Display/electronics unit	3
2.2.2	Sensor unit	4
3	Installation	4
3.1	Basic system	4
3.2	Display/electronics unit:	4
3.2.1	Power connection	4
3.2.2	Sensor unit/Encoder connection	5
3.2.3	Sensor unit/Encoder connection	5
3.2.4	External reset	6
3.2.5	Open collector outputs	6
3.2.6	Diagnose LEDs	6
3.3	Sensor unit/encoder:	7
3.3.1	Deck cable	8
4	Operation	8
4.1	Entering the menu/resetting the counter	8
4.2	The menu points	9
4.2.1	Resolution	9
4.2.2	Offset	9
4.2.3	Display	10
4.2.4	Display submenu	10
4.2.5	Alarm Lengths	11
4.2.6	Alarm length submenus	11
4.2.7	Baud rate	12
4.2.8	Protocol	12
4.2.9	Default	12
4.2.10	Store	13

Appendices

- Appendix 1: Flow diagram - Cable Status Indicator MKII
- Appendix 2: Drawing - Cut away, VA 198-2,
- Appendix 3: Drawing - Deck cable for sensor unit
- Appendix 4: Drawing - Meter counter system, Sensor unit with protection

1 Technical Description

The Cable Status Indicator MKII is part of the MacArtney Cable Sheave Block Package, but can also be used as a stand-alone unit, easily adaptable to any existing winch/sheave block installation.

The system consists of a sealed, splash-proof sensor unit, deck cable and display/electronics unit.

The display is of the LCD type with two lines of 16 digits. The display shows the length of cable outboard in metres and the speed of the cable in metres/minute or metres/second. From the front panel, the displayed length of the cable can be reset to zero or to a custom offset.

The resolution of the cable status indication depends on the sensor and sheave used. The resolution is adjusted from the front panel and can be set from 1 mm to 999 mm. Please go to section 4 for instructions on resolution setting.

It is possible to connect a computer to the Cable Status Indicator MKII via RS232 or RS422 communication ports. The Cable Status Indicator continuously transmits a string showing length and speed of the cable. This string can also be sent to another Cable Status Indicator MKII set as slave.

2 Specifications

2.1 Electrical

2.1.1 Display/electronics unit

Power supply:	85-264 VAC and 120-370 VDC 10-18 VAC, 12-24 VDC (as specified on the unit)
Power connection:	3 pin screw terminal
Display:	LCD display with 2 lines of 16 digits
Sensor connection:	4 pin screw terminal
RS232 connection:	3 pin screw terminal
RS422:	4 pin screw terminal
External reset:	2 pin screw terminal
2 x O.C. outputs:	3 pin screw terminal

2.1.2 Sensor unit

Sensor elements:	Dual hall elements
Sensor connection:	SubConn® BH4M connector

2.2 Mechanical

2.2.1 Display/electronics unit

Overall dimensions:	Height:	48 mm
	Width:	96 mm
	Depth:	95 mm
Cut away dimensions:	Height:	43.8 mm
	Width:	90 mm

2.2.2 Sensor unit

Dimensions:	Height:	116 mm
	Width:	44 mm

3 Installation

3.1 Basic system

The basic Cable Status Indicator MKII system includes the following components:

- Display/electronics unit
- Deck cable
- Sensor unit

3.2 Display/electronics unit:

The display/electronics unit is ideal for panel mounting. When the mounting hole has been made according to the cut-away drawing, the display/electronics unit can be installed using the two mounting clamps supplied with the unit.

3.2.1 Power connection



The power must be connected to the mains screw terminal (J1) as shown below.

The picture shows J1.
The labels tell how to connect the power.

Terminal 1 is the PE (protective earth) connector.
Terminal 2 is the neutral/- connector.
Terminal 3 is the Line/ + connector.

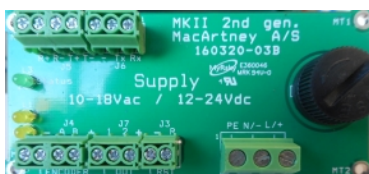

AC supplied unit

Connect line conductor to L/+ connector.
Connect neutral conductor to N/- connector.
Connect protective earth conductor to PE.



DC supplied unit

Connect + supply conductor to L/+ connector.
Connect 0V conductor to N/- connector.
Connect protective earth conductor to PE.

3.2.2 Sensor unit/Encoder connection

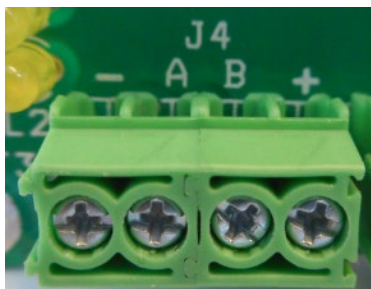

The deck cable is connected to the screw terminal (J4) as follows:

- White is connected to + terminal.
- Grey is connected to – terminal.
- White/grey is connected to A terminal.
- White/blue is connected to B terminal.

See also appendix 3

The colours of the cable may differ from the one shown, in case an older deck cable is used.

Contact MacArtney, in case there is confusion regarding this connection.

3.2.3 Sensor unit/Encoder connection

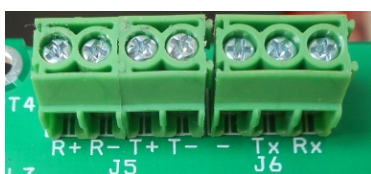

The MKII unit provides both RS232 (J6) and RS422 (J5) serial interface.

RS232 is used for a cable length of up to approx 15 metres. When longer cables are required, RS422 is recommended.

The unit transmits data on both interfaces. It also receives data on both interfaces.

However, it can only use one of the two interfaces at a time.

Sending data to the unit on both interfaces will “jam” the receiver of the unit.

The baud rate/format is default 9600,n,8,1. The baud rate may be changed via the menu.

The serial interface is used by the MKII to send data to either a PC, another MKII setup as slave, a Jumbo display or any other equipment with a serial interface.

When the Cable Status Indicator MKII is used in slave setting, it must be connected to the master with RS232 or RS422.

Connection for RS42–2

Master	Slave
RS422 RX+*	RS422 TX+*
RS422 RX-*	RS422 TX-*
RS422 TX+	RS422 RX+
RS422 TX-	RS422 RX-
RS232 -**	RS232 -**

Connection for RS232

Master	Slave
RS232 RX*	RS232 TX*
RS232 TX	RS232 RX
RS232 -	RS232 -

*The master sends data to the slave only. Therefore, there is no need for wires for communication from the slave to the master.

** A GND connection may be required for long RS422 cables to ensure that no large common-mode voltage is measured.

3.2.4 External reset



The counter may be reset via a push button or a relay contact connected to the two terminals labelled "R" and "-" in the connector J3.

The input must be activated for approx 2.5 seconds before the counter is reset. This prevents accidental resets.

The reset can also be effected via the menu from the front or via serial interface from a PC programme.

3.2.5 Open collector outputs



There are two open connector outputs, which can drive external relays, activate inputs in a control system, etc.

The outputs are open collector outputs driving the output to GND/0V when turned on.

The outputs are capable of sinking up to 0.5 A.

Typically, the external relays must be 24 VDC coil relays as amplitude on the "+" terminal is 24V.

Note: In case the supply is 10-18 VAC or 12-24 VDC, the level on the "+" terminal depends on the supply level.

The relays must be connected between the + terminal and one of the two output terminals (1 & 2) in J7.

Free wheeling diodes are found in the display unit.

The function of the relay is set up via the menu.

3.2.6 Diagnose LEDs

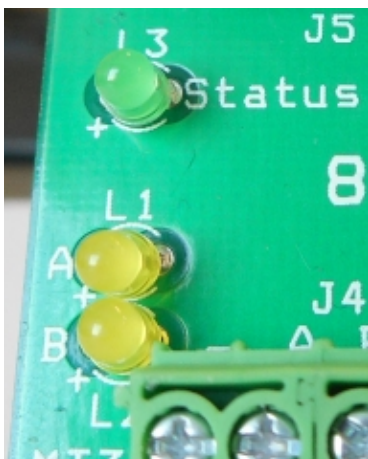

There are three LEDs on the backside of the unit.

Two LEDs show the activity on the A & B inputs and may be used to determine if the sensor unit/encoder output is working properly.

The LEDs will be on when the sensor detects the magnet on the sheave. These LEDs are labelled "A" and "B".

The third LED shows if the unit works properly. When flashing slowly (once per second), the display unit runs properly.

When flashing rapidly, the serial data has been received and accepted by the unit. After reception of valid data, it will flash rapidly for approx 3 seconds before starting to flash slowly again.

This LED is labelled "Status".

The LED can be used to determine if the serial communication is running properly.

3.3 Sensor unit/encoder:

The sensor unit is installed on the side of the sheave block and the deck cable connected (SubConn® connector).

Finally, the magnets (2 x) must be installed on the sheave wheel. If the cable sheave system is delivered together with the Cable Status Indicator from MacArtney, the magnets have already been installed.

If the Cable Status Indicator system has been delivered to fit an existing cable block system, the following installation procedure must be followed:

- Drill four threaded holes (M4) and two free holes (14 mm) in the side of the cable block (cf. drawing VA 198-2, appendix 2).
- Install the sensor unit using four stainless steel M4 screws.
- Install a minimum of one magnet on the sheave wheel with the North Pole pointed at the sensor elements.
- The distance between the magnet and the sensor heads should be within 1 – 5 mm.

Please note that more magnets can be installed on the sheave wheel in order to increase the resolution and update rate. However, the distance between each individual magnet is recommended to be uniform.

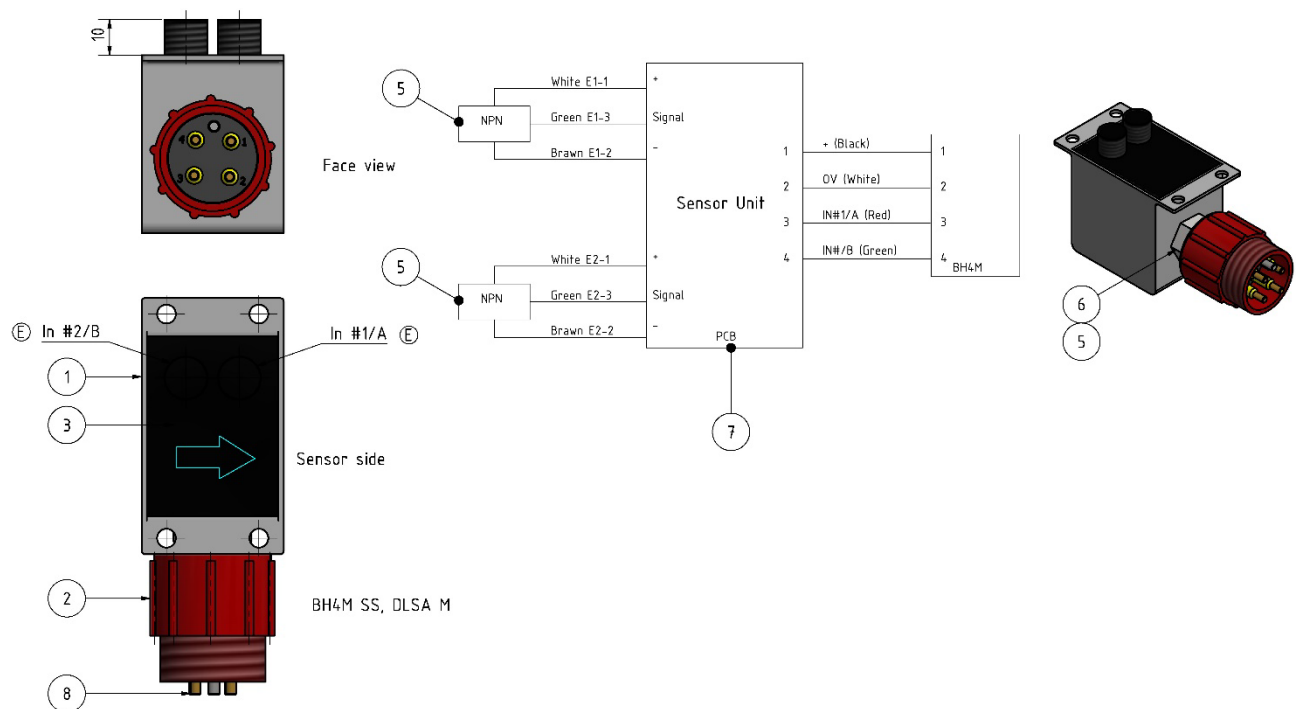

The pictures show the sensor unit/encoder

- Pin 1 in the SubConn is + supply for the sensor unit, which must be in the range 10 – 30Vdc.
- Pin 2 in the SubConn is 0V/- supply for the sensor unit
- Pin 3 in the SubConn is the A signal from the sensor unit
- Pin 4 in the SubConn is the B signal from the sensor unit

A graphical setup of the sensor unit/encoder can be found in appendix 4, too.

Once connected to the MKII unit as described above, the functionality may be tested by slowly turning the sheave and observing the LEDs on the backside of the MKII unit. The LEDs A and B must flash to indicate that the sensors on the sensor unit detect the magnets.

3.3.1 Deck cable

The deck cable connects the sensor unit/encoder on the sheave with the MKII unit. The default length is 30 metres. The length can be increased if needed up to >100 meter.

Other lengths may be requested.

4 Operation

All functions on the Cable Status Indicator MKII are accessible from the front panel of the display unit. However, the menu varies according to the mode (master or slave). The remaining functions can be operated with three buttons: "Enter", "Arrow Up" and "Arrow Right".

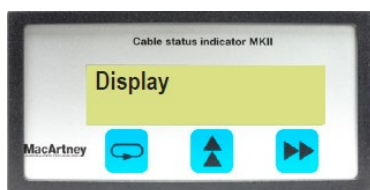

- Pressing "Arrow Right" will toggle backlight on the LCD display between off/half/full when not in the menu.
- By pressing "Arrow Up" you can either enter the menu or reset the counter.
- To toggle through the menu, press "Arrow Right".
- To exit menu, press "Arrow Up".
- To change settings in one of the functions, press "Enter".

The functions are described in detail below. A graphical setup of how to operate the menu can be found in appendix 1, too.

All the parameters can also be set via the PC programme.

4.1 Entering the menu/resetting the counter

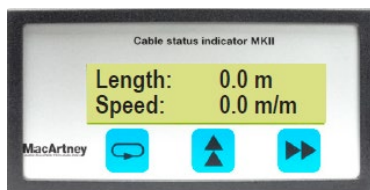

By pressing the "Arrow Up", you can either enter the menu or reset the cable counter as shown on the picture.

To reset the counter value, press the "Arrow Right" button. The counter is set to the offset value, which is default 0 when done.



To enter the menu, press the "Enter" button.

In the menu, various setup parameters can be changed. The different parameters are described below.

In the menu, step through the different points by pressing the "Arrow Right" button.

To select a point, press the "Enter" button.

To get back to normal function without entering the menu or resetting, simply press the "Arrow Up" button again.

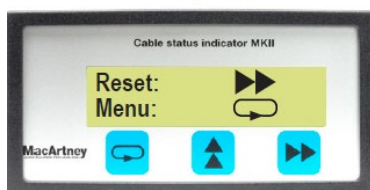

4.2 The menu points

4.2.1 Resolution

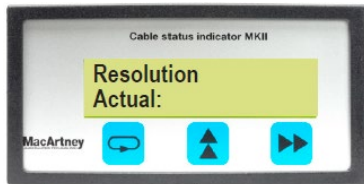

This function sets the resolution of the cable status indicator. Resolution is entered in mm.

The actual resolution is seen on the lower line.

The resolution is the distance between the magnets on the sheave.

The resolution can be calculated by using the following formula:

$$\frac{O_m}{N} = \frac{2 \times \pi \times R}{N}$$

Where:

N = Number of magnets in the sheave

R = Radius of sheave in mm measured from the centre to the point of the sheave where the cable touches the sheave.

To select "Resolution", press "Enter".

To set the resolution, press "Arrow Right" to move between digits. To change the digits, press "Arrow Up".

To exit "Resolution", press "Enter" again. The new value is now used until power is turned off.

To store it permanently, use the "Store" function.

4.2.2 Offset

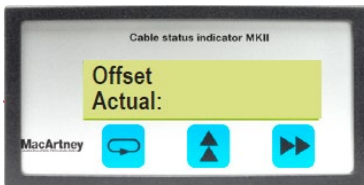

The offset value is the value, which will be saved in the counter when reset.

The offset value is entered in metres.

The actual offset is seen on the lower line.

The default value is 0.

The maximum offset is 255 m, and minimum is 0 m.

To select "Offset", press "Enter".

Press "Arrow Right" to toggle between the digits. Press "Arrow Up" to change value of digits.

To exit "Offset", press "Enter" again. The new value is now used until power is turned off.

To store offset permanently, use the "Store" function.

4.2.3 Display

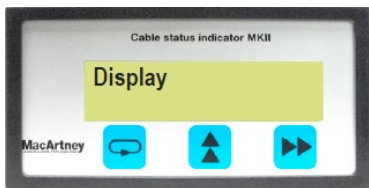

The display menu has submenus.

To enter the display menu, press "Enter". Then the submenu starts.

To leave the sub menu and return to this menu press "Enter" again.

To step through the submenu, use the "Arrow Left" button.

Pressing the "Arrow Up" button will force leave of menu.

4.2.4 Display submenu

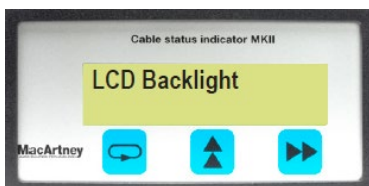

The default backlight intensity in the display can be set here.

There are 3 steps: 0% (off), 50% and 100%. The default value is 50%.

To enter the LCD Backlight menu press "Enter".

Press "Arrow Up" to shift between the 3 levels.

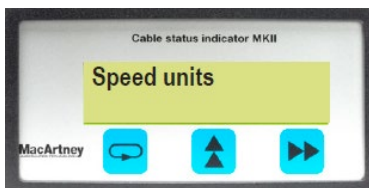

The Speed units can be either m/s (metre per second) or m/m (metre per minute)

The default is m/s.

To enter the Speed unit menu, press "Enter".

Press "Arrow Up" to toggle between the 2 options.

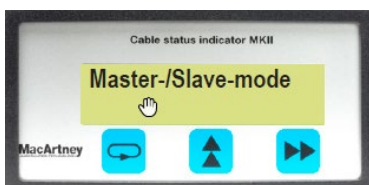

The MKII can be set up as a master (default) or as a slave.

When set up as a master, the MKII is a standard cable counter. When set up as a slave, it will display data received serially from an MKII setup as a Master.

To enter the Master/Slave menu, press "Enter".

Press "Arrow Up" to toggle between the 2 options.

Pressing the "Arrow Up" button will force leave of menu.

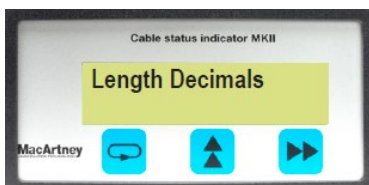

The length can be displayed with 0, 1 (default) or 2 decimals.

To enter the Length Decimals menu, press "Enter".

Press "Arrow Up" to shift between the 3 options.

Pressing the "Arrow Up" button will force leave of menu.

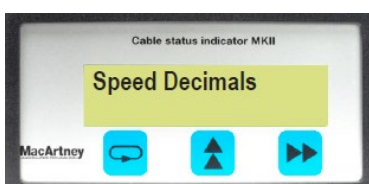

The speed can be displayed with 0, 1 (default) or 2 decimals.

To enter the Speed Decimals menu, press "Enter".

Press "Arrow Up" to shift between the 3 options.

Pressing the "Arrow Up" button will force leave of menu.

4.2.5 Alarm Lengths

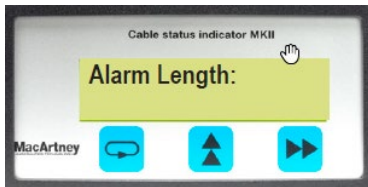

The Alarm Length menu has submenus.

To enter the Alarm Length, press “Enter”. Then the submenu starts.

To leave the submenu and return to this menu, press “Enter” again.

To step through the submenu, use the “Arrow Left” button.

Pressing the “Arrow Up” button will force leave of menu.

4.2.6 Alarm length submenus



The functionality of the open collector 1 output is determined via this setup.

To enter the Alarm function 1 submenu, press the “Enter” button.

To shift to the Alarm function 2 menu, press the “Arrow Left” button.



The functionality of the open collector 2 output is determined via this setup.

To enter the Alarm function 2 submenu, press the “Enter” button.

To shift to the Alarm function 1 menu, press the “Arrow Left” button.

When the “Enter” button is pressed, two submenus are available. To shift between them, use the “Arrow Left” button.

The functionality is the same function for both outputs. Below, it is shown for output 1 only.



The length at which the output changes state is set up here.

The actual length is shown on the lower line.

The length can be set between 0 and 4000 metres. The default value is 0 metre.

To set the value, use the “Arrow Up” to increase the digit value and the “Arrow Left” button to shift between the digits.

Press the “Enter” button to confirm that the setting has been completed.

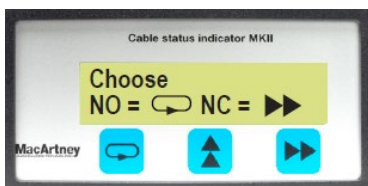

It can also be determined if the output is an N.O. or an N.C. type.

N.O. means normally open (inactive output). This is default.

N.C. means normally closed (active output).

4.2.7 Baud rate

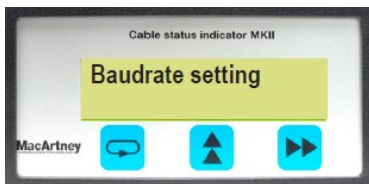

The baud rate of the serial communication can be set at 4800, 9600 or 19200 baud. The format is fixed at n,8,1.

9600 is the default baud rate.

To enter the baud rate setting, press "Enter".

Pressing the "Arrow Up" button will force leave of menu.

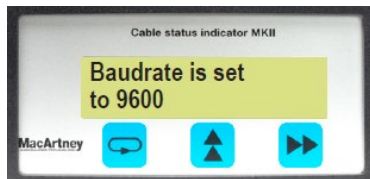

When "Enter" is pressed, the actual baud rate is shown.

Use the "Arrow Up" button to shift between the 3 options.

Press "Enter" to return to the main menu.

4.2.8 Protocol

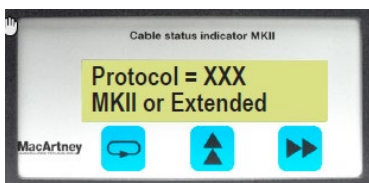

The MKII supports two different protocols.

The MKII is the protocol used in MKII 1st gen modules."

The MK II protocol is default.

The Extended protocol is a new protocol.

To enter the Protocol setup, press "Enter".

Pressing the "Arrow Up" button will force leave of menu.



When "Enter" is pressed, the actual protocol in use is shown.

The MKII protocol outputs two different strings.

L = ddd,d m (line feed), and S = dd,d m/min (line feed).

The protocols are described in detail in a separate document.

Contact MacArtney for further information.



Use the "Arrow Up" button to shift between the two protocols.

Press "Enter" to return to the main menu.

4.2.9 Default

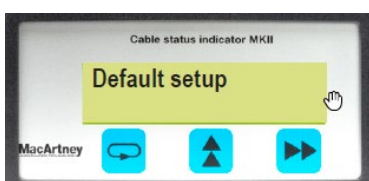

It is possible to make a default setup of all parameters via the menu.

To enter the Default setup, press "Enter".

Pressing the "Arrow Up" button will force leave of menu.

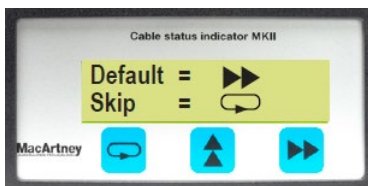

When “Enter” has been pressed, it must be confirmed that the parameters must be set to default values.

To actually select this, press the “Arrow right” button.

To regret the default setup, press the “Enter” button.

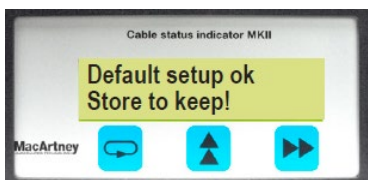

If default setup has been chosen, this text will appear for approx 1 second before returning to the normal mode.

4.2.10 Store

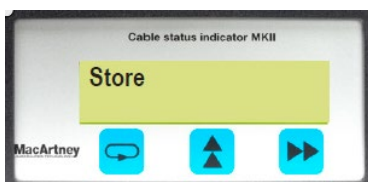

When the parameters/setup has been changed, it **MUST** be stored in non-volatile memory. Otherwise, the changes are lost, when power is removed from the MKII.

When the parameters are stored, they will be reloaded and used, when the MKII is powered again.

To enter the Store mode, press “Enter”.

Pressing the “Arrow Up” button will force leave of menu.

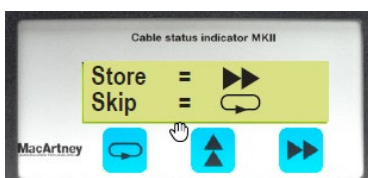

When “Enter” has been pressed, it must be confirmed that the parameters shall be stored.

To actually select this, press the “Arrow right” button.

To skip the store function, press the “Enter” button.

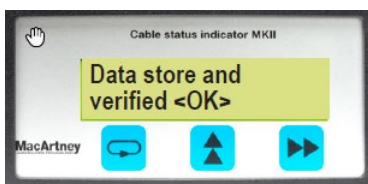

When the parameters have successfully been stored, this text will appear for approx. 1 second before returning to the normal mode

Appendix 1

Flow diagram Cable Status Indicator

Flow diagram Cable Status Indicator MKII

Main menu

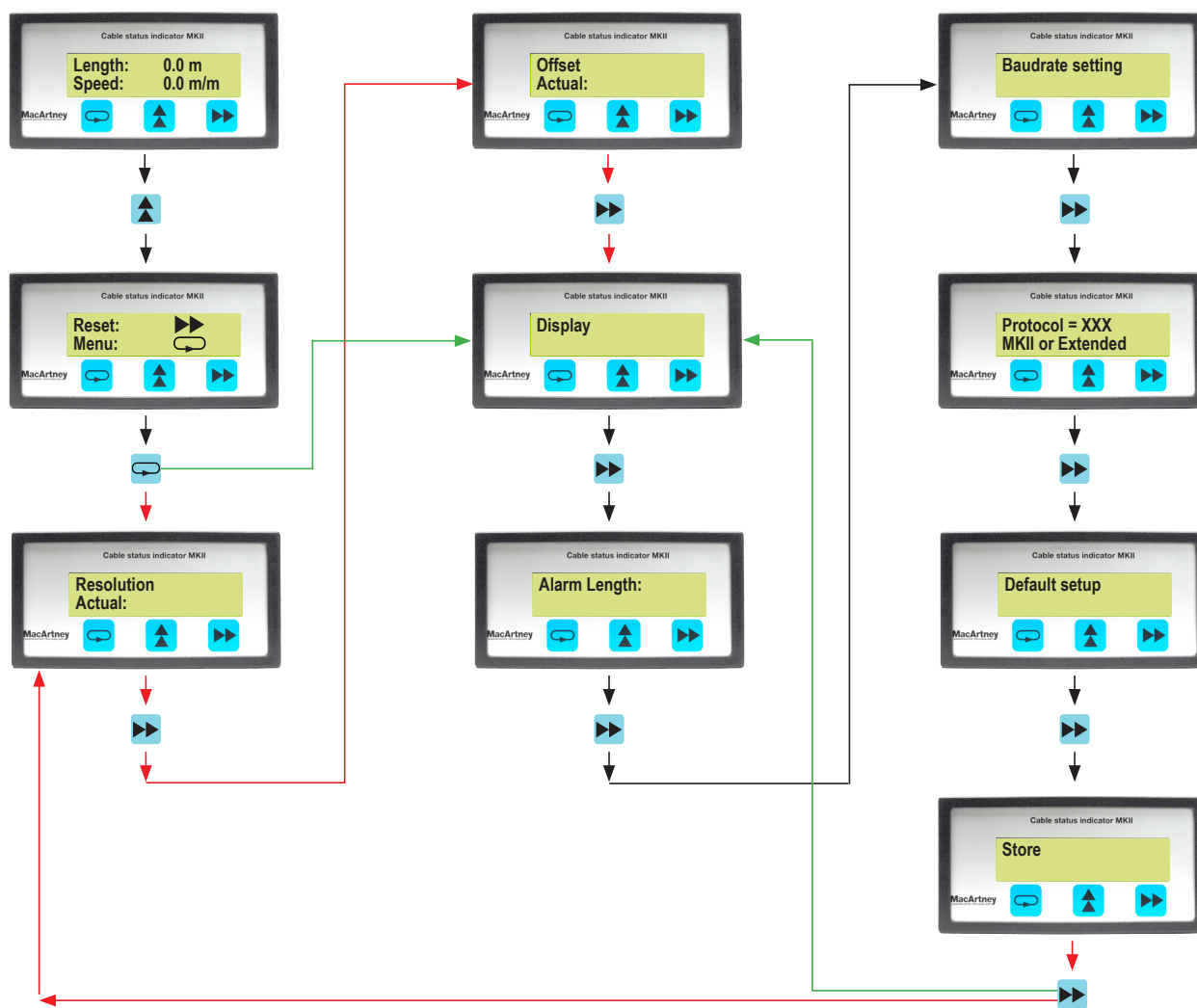

- All modes
 - Master mode
 - Slave mode
- Use to EXIT menu: ▲

Resolution

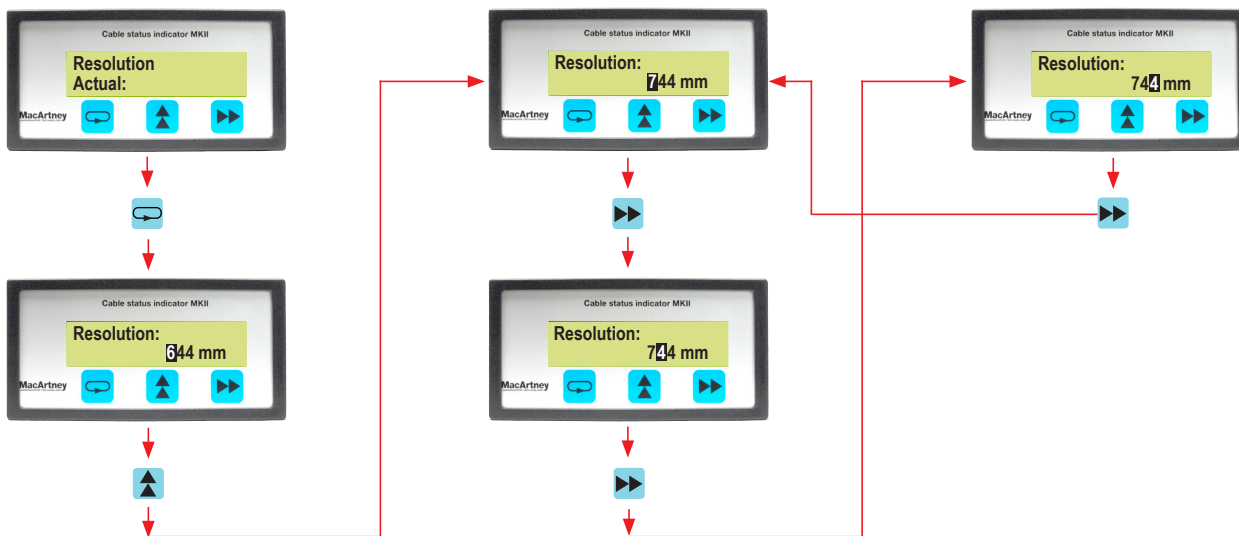

→ Master mode

Use to return to MAIN menu:

Offset

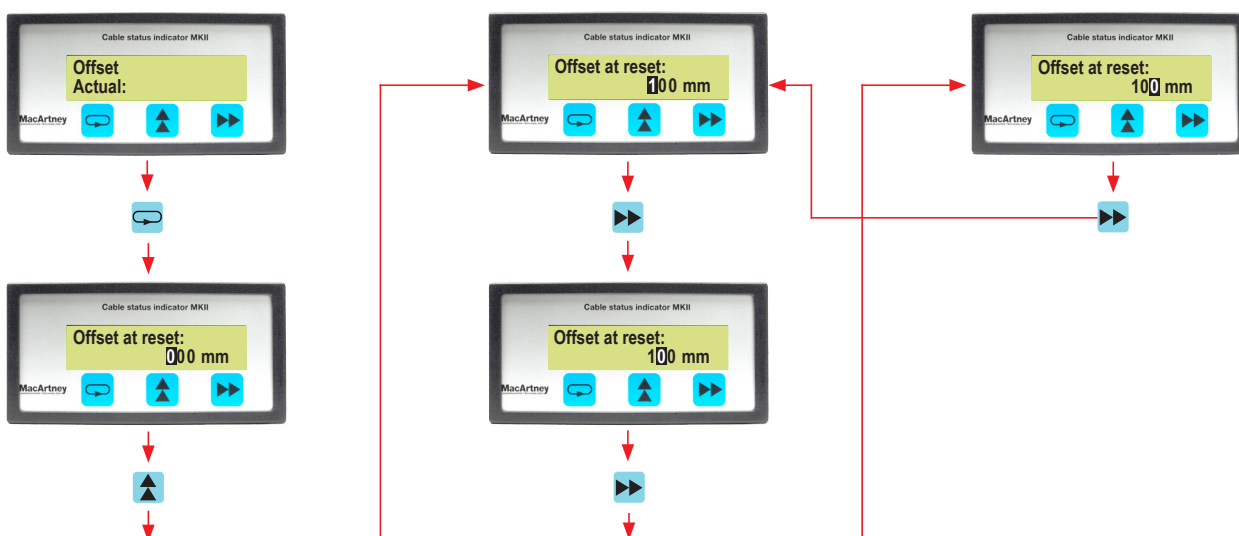

→ Master mode

Use to return to MAIN menu:

Display

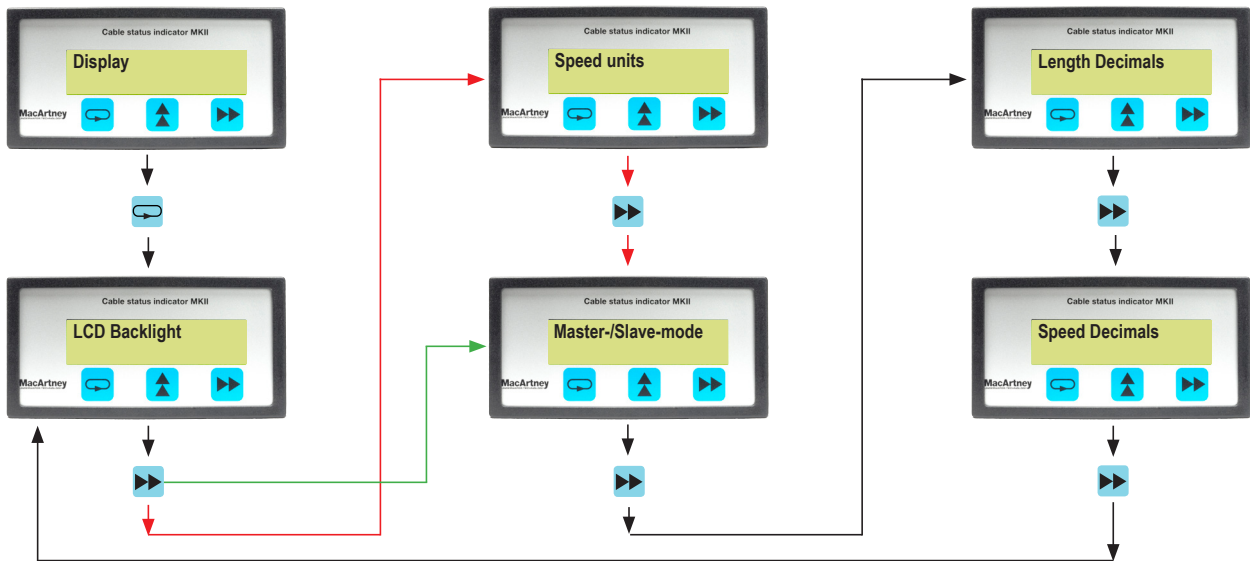

- ▶ All modes
- ▶ Master mode
- ▶ Slave mode

Use to return to MAIN menu:

LCD Backlight

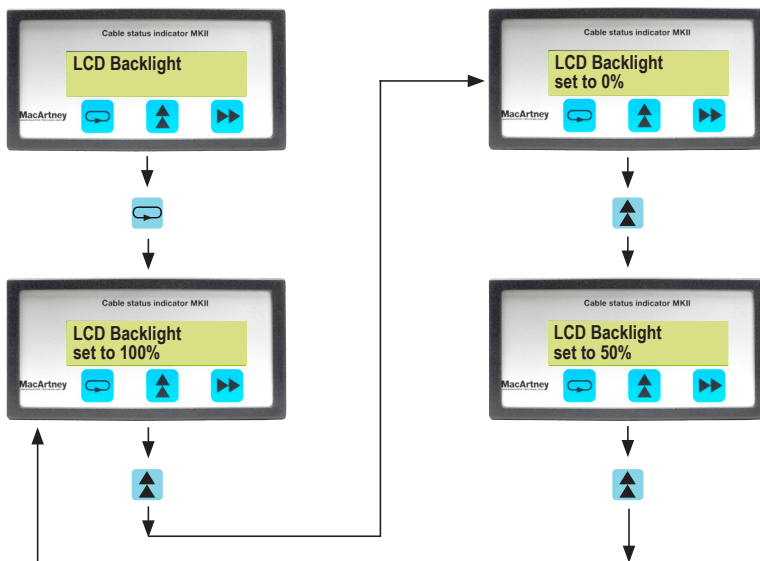

- ▶ All modes

Use to return to DISPLAY menu:

Speed units

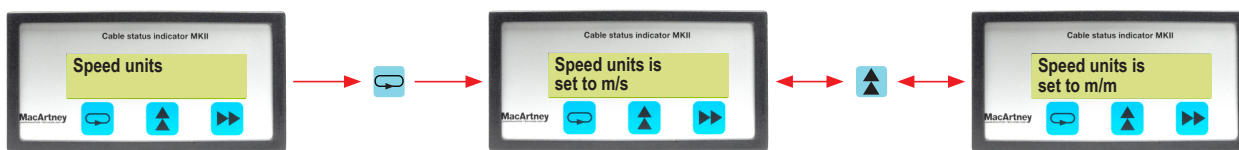

→ Master mode

Use to return to DISPLAY menu:

Master/slave

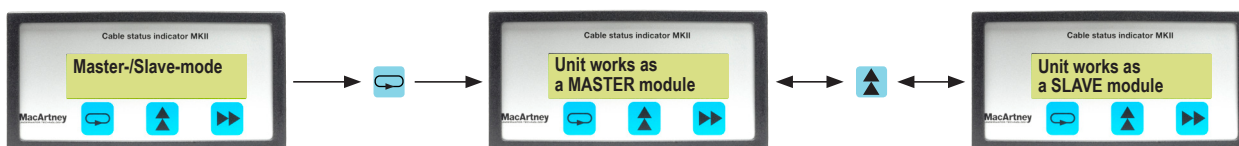

→ All modes

Use to return to DISPLAY menu:

Length Decimals

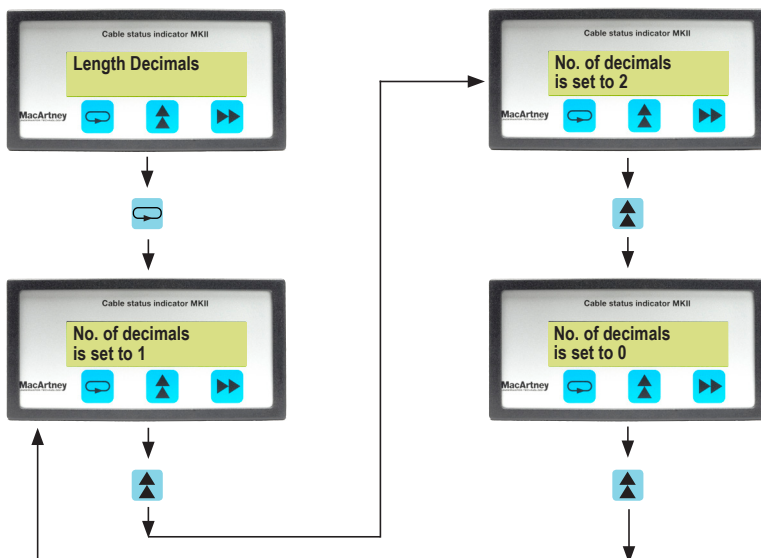

→ All modes

Use to return to DISPLAY menu:

Speed Decimals

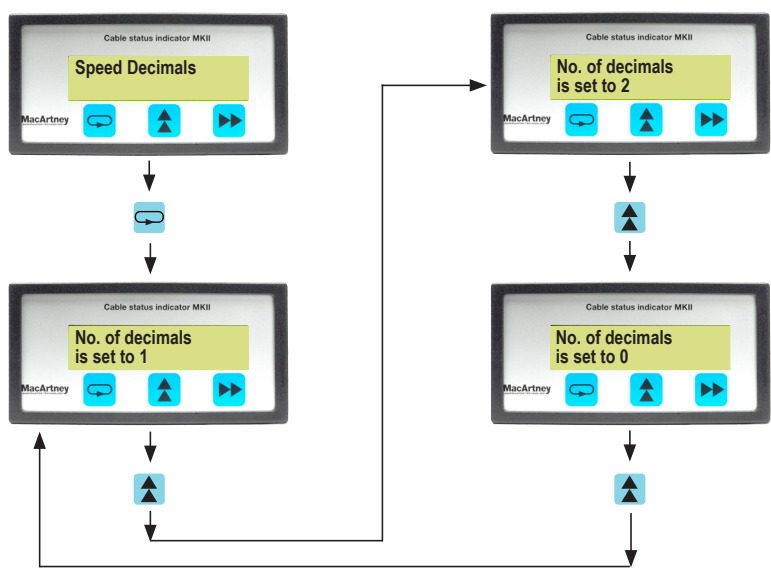

→ All modes

Use to return to DISPLAY menu: 

Alarm Length

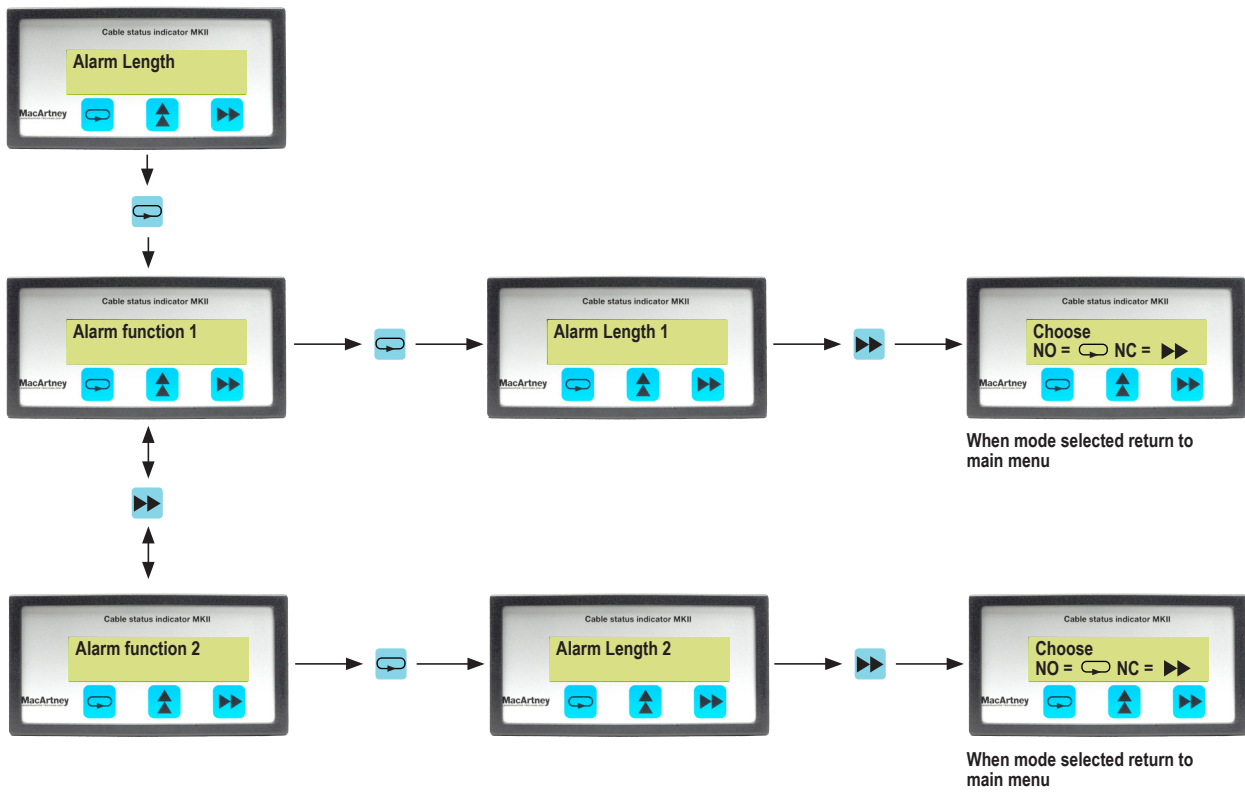

→ All modes

Use to return to MAIN menu - in Alarm function 1 or 2:

Use to return to Alarm function 1 in any other menus:

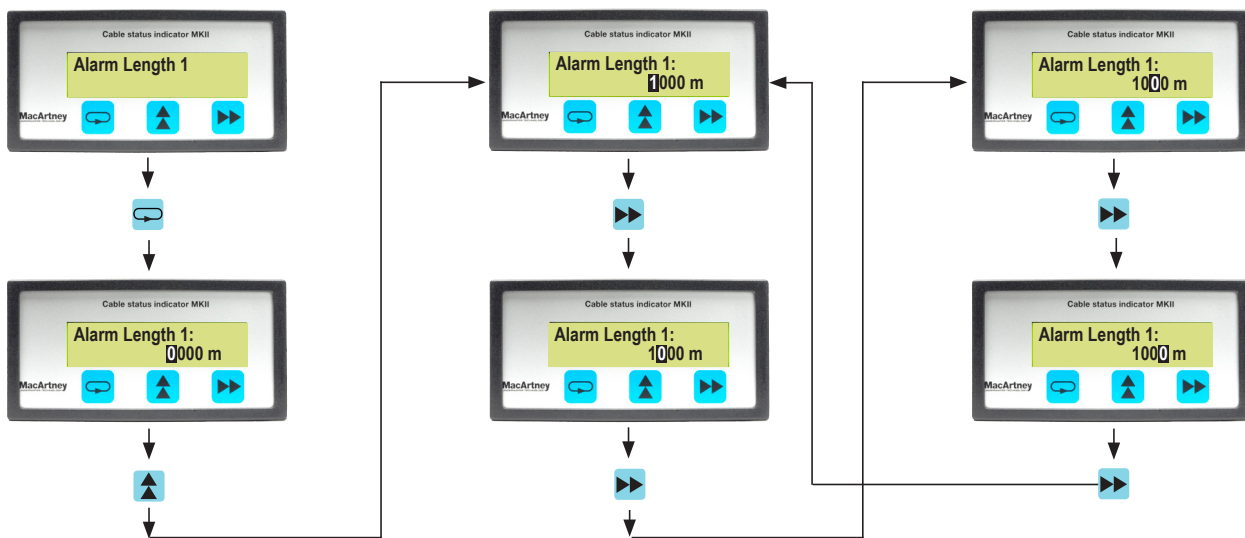

→ All modes

Use to return to Alarm function 1:

Baudrate setting

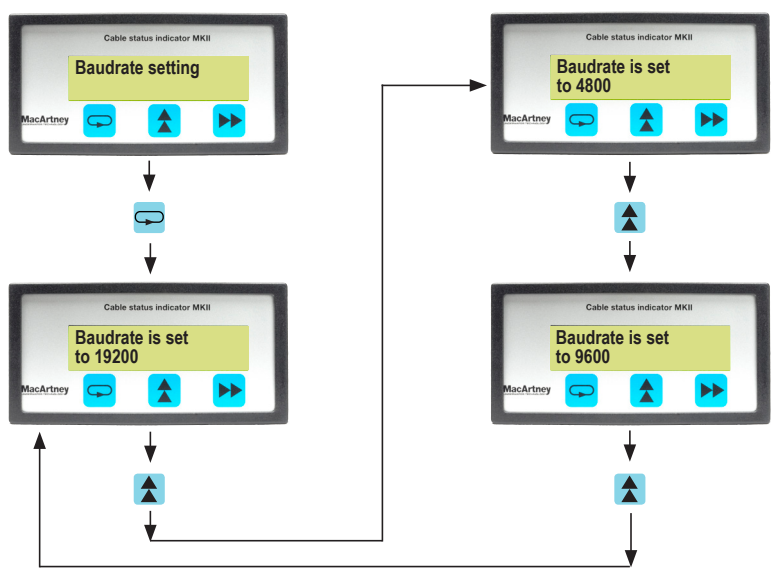

→ All modes

Use to return to MAIN menu: [Left Arrow Button]

Protocol

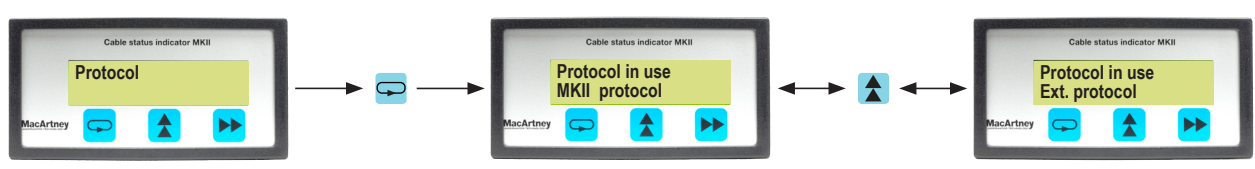

→ All modes

Use to return to MAIN menu: [Left Arrow Button]

Default setup

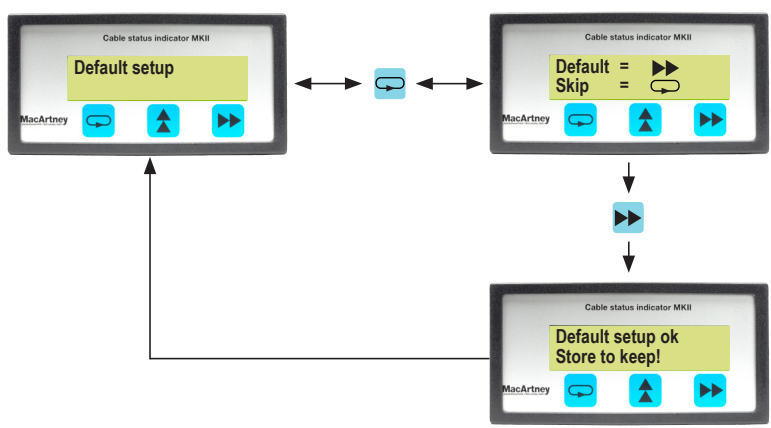

→ All modes

Store

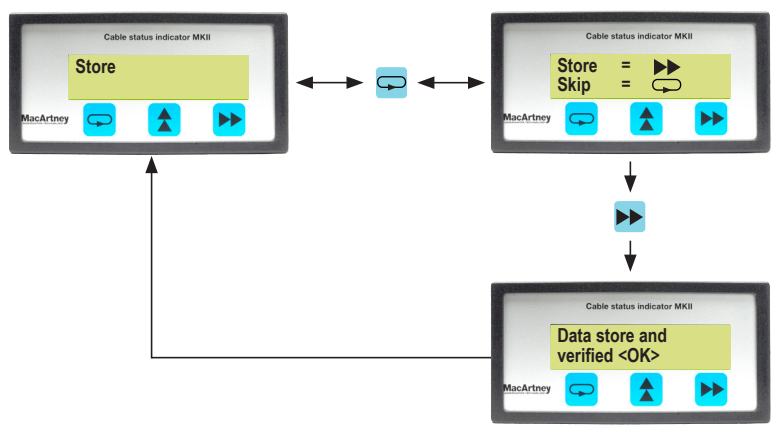

→ All modes

Appendix 2

Drawing VA 198-2

Display / Electrical Unit

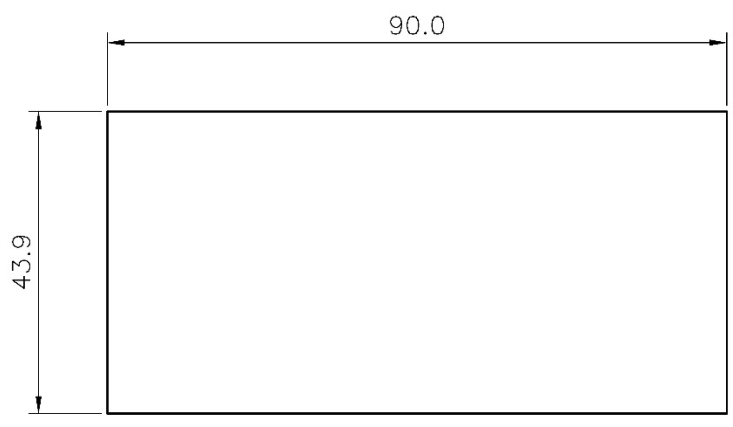

Sensor Unit

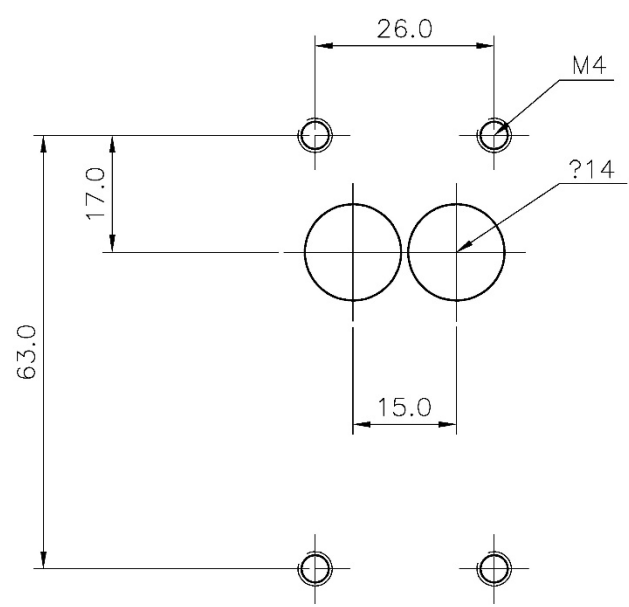

This drawing is the property of MacArtney A/S, and must not be copied or shown to a third person without permission.

Customer no. :	-
Customer ref. :	-
DS 989.3	
Scale :	1:1
Tol. :	DS 2075
Surface :	-
Matr. :	-



Cut away Drawing

Drawn	ESC	100892
Check		
Approved		
Drawing no.	Rev.	
VA198-2A		

Appendix 3

Drawing Deck cable for sensor unit

This drawing is the property of MacArtney A/S, and must not be copied or shown to a third person without permission.

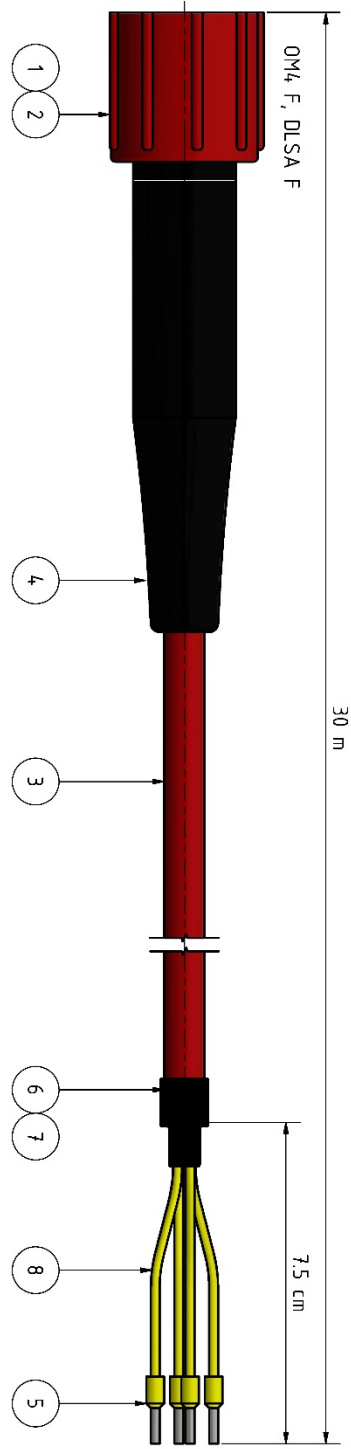

Face view

OM4 F	Wire Color	Wire Size	Terminal
1	Brown	0.75 mm ²	White 0.5 mm ² + Supply
2	Grey or Blue	0.75 mm ²	Grey 0.5 mm ² GND
3	Yellow/Green	0.75 mm ²	White/Grey 0.5 mm ² In #1/A
4	Black	0.75 mm ²	White/Blue 0.5 mm ² In #2/B

If nothing else is specified the tolerance regarding the cable length is ± 3%

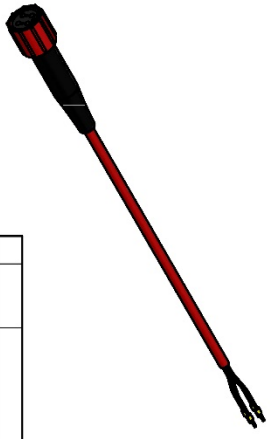

Rev	Date	Reason for Issue	Dm.	CHK
A	22/10/08	For Production - Changed to Inventor.	LH	SH
B	22/10/08	As Built	LH	SH
C	3/10/09	Added Mac no 20401030	DM	LH
D	16/11/11	Pos 5 added	SH	SKR
E	05/03/17	Pos 6, 7 & 8 added. Wiring corrected!	LH	JEB

Pos	Qty	Mac No.	Description	Material
1	1	01004040	DLSA-F Lock sleeve	Red
2	1	01306010	OM4F Subconn conn.	1000029
3	1	11903160	Flexipour cable 4x0.75mm2	PUr
4	1	C	Moulding SA8	10732
5	4	C	Terminal tube	N/A
6	4	C	Heat shrink	N/A
7	1	C	Heat shrink - Overall	N/A
8	4	C	Pigtail LIVVY 0.5 mm ²	N/A

MacArtney
UNDERWATER TECHNOLOGY

DECK CABLE (20401030)

For sensor unit 30m

Drawn	LH	22-10-2008
Checked	SH	22-10-2008
Drawing no.:	0040070000-010	
Sheet no.:	1	Rev.:
Sheet no.:	1	Rev.:
Supplier:	Supplier Part No	
Supplier:	Supplier Part No	
Reference:	V-564-12 Rev.B	

Appendix 4

Drawing

Meter counter system Sensor unit with protection

This drawing is the property of MacArtney A/S, and must not be copied or shown to a third person without permission.

